



SURETHERM

User Manual



SURETHERM 10X

SURETHERM 20X

SURETHERM 30X



ISO 9001:2008
ID 9108623968
www.tuv.com



ADDRESS TM Induction Heating
Nobelstraat 14
3846 CG Harderwijk
The Netherlands

T & M Techniek BV
BTW NL800643136B01
KvK 08054481

WEB tminductionheating.com
MAIL info@tminductionheating.com
TEL +31 (0) 341 434454
FAX +31 (0) 341 434464



ISO 9001:2008
ID 9108623968
www.tuv.com

Note

Check delivery for possible damage caused by transport without delay. Should damage be detected, please inform carriers immediately.

As our products are subject to continuous improvement, we reserve the right to make changes.



CONTENTS

1	INDUCTION HEATING	5
	Operating conditions	5
2	SAFETY GUIDELINES	6
	Safety precautions	7
	Safety instructions	8
	Safety features	9
3	INSTALLATION	10
	Scope of delivery	10
	Unboxing	10
	Installation process	11
4	SETTING UP THE WORKPIECE	12
	Choosing the yoke	13
	Positioning the magnetic temperature probe(s)	14
5	OPERATION	15
	Temperature Mode, using one sensor	16
	Ramp Mode	17
	Temperature Mode, using two sensors	18
	Time Mode	19
	User menu	20
6	MAINTENANCE	21
7	MALFUNCTION	22
	Adjusting the yoke	22
	Errors	23
8	SPECIFICATIONS	24
	Dimensions	25
	Workpiece dimensions	26
	Technical data	27
	Extra information	28
	Electrical drawing	29
9	STATEMENT OF CONFORMITY	31





INDUCTION HEATING

1

SURETHERM induction heaters are used to heat rolling bearings. Other metal components forming a closed circuit such as bushings, shrink rings, pulleys and gears can also be heated. This will facilitate mounting where an interference fit is required.

Our range of standard heaters are designed to heat the workpiece to a maximum temperature of 240°C (464°F). The heaters can be used on a continuous basis. Always place the temperature sensor on the workpiece to check the heating cycle. When heating an object using Time Mode, the heating cycle must be checked using an external temperature meter.

Bearings generally should only be heated to a maximum temperature of 120°C (248°F). Do not use induction heaters for bearings or workpieces with dimensions outside the ranges specified in this manual. Do not switch off the heater with the main switch while heating cycle is running.



CAUTION

The heater is designed to be used in an industrial environment with an ambient temperature of 0°C to 40°C (32°F to 104°F) and an atmospheric humidity between 5% and 90%, non-condensing. The induction heater is intended for indoor use only.

**OPERATING
CONDITIONS**

2 SAFETY GUIDELINES

The operating instructions should always be followed when using an induction heater.

TM Induction Heating shall not be held liable for damages caused by improper handling or by use which does not comply with the designated purpose. Prerequisites for the operator: He/she must be authorised for use of the heater and must be familiar with the safety precautions.

In order to prevent danger or damage to the induction heater or workpiece, follow these guidelines:

- ▶ All repairs must be carried out by an official TM Induction Heating distributor.
- ▶ Use original spare parts only.
- ▶ Protect the heater from water or very high humidity.
- ▶ Protect the heater core and yokes against corrosion, damage and deformation.
- ▶ Only preheat bearings to max. 120°C (248°F).
- ▶ To ensure proper operation of the device, it is important to provide the device with the latest software updates. A description can be found in chapter 5 - [OPERATION](#), page 20 - [USER MENU](#).

- ▶ Since a magnetic field ^{4&5} is generated by the induction heater, people wearing a pacemaker ¹ or other implant device ² should not work or be in the immediate vicinity of the device. Other sensitive equipment such as wrist watches, magnetic carriers, electronic circuits, etc. ³ might also be affected. The safety distance is 0.5 meters (19”).
- ▶ Use protective gloves as protection against burns to hands. The gloves delivered are suitable for use up to temperatures of 150°C (302°F).
- ▶ Hot surface, avoid contact ⁶.
- ▶ Do not operate an induction heater in areas where there is risk of explosion.
- ▶ Wear safety shoes ⁸.

SAFETY PRECAUTIONS



SAFETY INSTRUCTIONS

- ▶ The user should have an appreciation of the contents of this user manual, and be familiar with safe workshop practices.
- ▶ Follow the user manual at all times.
- ▶ Ensure that the induction heater operates at the correct supply voltage. If the heater is not supplied with a plug, changes should only be made by a suitably qualified electrician.
- ▶ Do not use or store the heater in humid environments. The heater is designed for indoor use only.
- ▶ Use proper handling equipment, appropriate for the weight of the workpiece and/or yoke. Never support components with a metal cable or have any hanging in the proximity of the magnetic field. Extremely high currents can flow through the cable causing it to heat up quickly, resulting in a risk of burning.
- ▶ Do not place any metal objects near the yokes and poles.
- ▶ Place heater on a stable, horizontal surface.
- ▶ Keep a minimum distance of 1 metre (38") to surrounding objects.
- ▶ Use only in well ventilated areas.
- ▶ Do not heat objects containing oil, grease or similar substances. Prevent possible generation of fumes and smoke.
- ▶ Do not inhale fumes or smoke from heated parts.
- ▶ Do not move or lift heater when warm after heating cycle.
- ▶ Do not touch the heater core during heating cycle.

Should an error occur during the heating process, the induction heater will automatically stop. The corresponding error will be displayed on screen. In the case of user error, the display indicates what steps are to be taken to correct the problem. More information about the types of errors can be found in chapter 7 - **ERRORS**.

SAFETY FEATURES

An induction heater produces an electromagnetic field within a coil to transfer energy to a workpiece. The table below shows values of the flux density in microTesla (μT). These measurements can be used as a guide

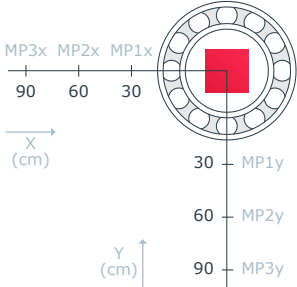

conforming to local regulations regarding the maximum time exposure to magnetic fields. Different configurations may give different values. It is impossible to provide values for all combinations as the variety of bearing types in combination with the different yokes is large.

	SURETHERM 10X	20X	30X
Measurement position (cm)		B-field_{total} (μT)	
MP1x	81	249	283
MP2x	16	34	74
MP3x	1	11	28
MP1y	156	181	185
MP2y	27	24	78
MP3y	9	9	41

Total 50Hz RMS field for magnetic measurement results. Max. magnetic flux in safe exposure area, according to the German BG 11 Regulations is 423 μT .

3

INSTALLATION

SCOPE OF DELIVERY

Contents of the box

1. SURETHERM 10X/20X/30X
2. Yoke(s)
3. Temperature probe(s)
4. Heat-resistant gloves
5. User Manual
6. Quickstart guide



Note

The SURETHERM 10X comes with yokes 14, 25, and 40 included. The yokes for SURETHERM 20X and SURETHERM 30X are all optional. The heat-resistant gloves may differ from the picture above.

UNBOXING

Follow the instructions specific for this heater on the supplied Quickstart guide. If the Quickstart guide is not included in this box, please contact your distributor or TM Induction Heating directly. The induction heater must always be transported in the original box, thus also on return to the manufacturer/distributor.



Ensure that supply voltage and current meet the specifications. These can be found on the type plate at the back of the induction heater.

Each induction heater is provided with a plug, but there are a large number of plug types. Should the plug not fit your power supply, a suitable plug must be affixed by a qualified electrician. Voltages may differ for customized heaters.



INSTALLATION PROCESS

Voltage	Phase	Neutral	Ground
110-230V	<ul style="list-style-type: none"> ■ Brown ■ Black (USA) 	<ul style="list-style-type: none"> ■ Blue White (USA) 	<ul style="list-style-type: none"> ■ Green/Yellow
110-230V	<ul style="list-style-type: none"> ■ Brown ■ Black (USA) 	<ul style="list-style-type: none"> ■ Blue White (USA) 	<ul style="list-style-type: none"> ■ Green/Yellow

10X

20X

Voltage	Phase X / L1	Phase Y / L2	Ground
400-440V	<ul style="list-style-type: none"> ■ Brown ■ Black 	<ul style="list-style-type: none"> ■ Black ■ Black 	<ul style="list-style-type: none"> ■ Green/Yellow
460-575V	<ul style="list-style-type: none"> ■ Black 	<ul style="list-style-type: none"> ■ Black 	<ul style="list-style-type: none"> ■ Green/Yellow

30X

30X

Insert the plug into a shockproof wall socket and then connect the heater to mains electricity.

Turn main switch from 0 to 1. The heater will emit a short beep and the touchscreen displays the main menu. The induction heater is now ready for use.



4

SETTING UP THE WORKPIECE

The workpiece can be set up in two different ways and must never touch the housing. Small objects are to be heated in a vertical position.



- ▶ Use appropriate hoisting equipment for heavy components and yokes. Manual lifting of heavy objects is a common cause of injury.
- ▶ Wear safety shoes during these procedures.
- ▶ The weight of the work-piece should not exceed the maximum weight as shown in chapter 8 - **WORKPIECE DIMENSIONS**. Exceeding these limits may result in catastrophic equipment failure and may also lead to personal injury.
- ▶ Ensure there is no contact between the mains cable and the workpiece. Damage to the cable may result in electrocution.
- ▶ Never support components with a metal cable and avoid metal cables hanging in the proximity of the magnetic field. Extremely high currents can flow through the cable causing it to heat quickly, resulting in risk of burning.



- ▶ Choose largest possible yoke which fits the diameter of the workpiece. Position the workpiece onto the yoke and place the yoke with the machine milled surface on the poles of the heater core.

CHOOSING THE YOKE

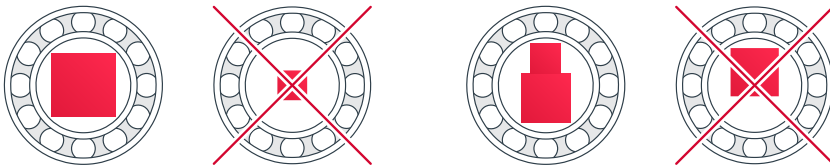

- ▶ Always make sure that the workpiece avoids direct contact with the housing of the heater.
- ▶ When a heating cycle is completed, always wear heat-resistant gloves. The maximum temperature of the workpiece on a standard induction heater is 240°C (464°F).
- ▶ Always treat yokes carefully. Falling, bumping, etc. can damage the yoke and/or cause personal injury. Always store the yoke safely immediately after use.

POSITIONING THE MAGNETIC TEMPERATURE PROBE(S)

- ▶ Always use the magnetic temperature probe (hereafter referred to as the 'probe') for heating in Temperature Mode or Ramp Mode.
- ▶ Place the probe on the workpiece, close to the bore. Make sure that the surface used for the probe is free of grease and/or oil.

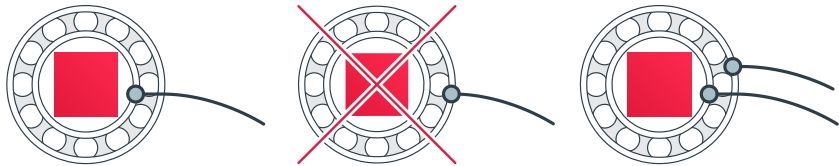

- ▶ If the induction heater has two probes: place one close to the bore and the other on the outer ring.
- ▶ Our standard probes are suitable for operation up to a maximum temperature of 240°C (464°F). The connection between magnet and probe will break above the maximum temperature. If this occurs when operating in Temperature Mode, the heater will turn itself off as the probe will fail to register any increase in the temperature over a set period of time. Probes for higher temperatures are optional.
- ▶ Connect the probe by inserting the plug into the socket at the front of the heater, with the red dot facing upwards.



Treat the probe with care. It is a valuable part of the heater and can easily be damaged through careless handling. After use, we suggest that it be placed on the side of the vertical pole.

OPERATION

5

When the induction heater is turned on, the homescreen can show up to four buttons with different modes; Time Mode is always available. Temperature Mode (with 1 sensor) and Ramp Mode will be enabled when



one sensor is inserted. An extra Temperature Mode (with 2 sensors) will be enabled when a second sensor is inserted.

The start/stop button is used for starting heating cycles in one of the modes, or to stop a heating cycle at any time.

When a heating cycle is complete, or stopped prematurely, the program will return to the main screen of the heating mode. A graph can be requested with the graph button .

Every mode has three stages:

- 1. Preparation** - *The user can change the temperature and/or time.*
- 2. Heating process** - *The induction heater starts the heating cycle.*
- 3. Completion** - *The heating cycle has ended.*



TEMPERATURE MODE, ONE SENSOR

1. PREPARATION

To change the temperature press **110°C**. Otherwise proceed to step 2.

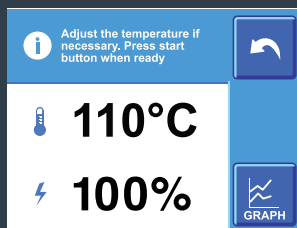

Press **+** or **-** to change the temperature (max. 240°C).

Press **✓** when the temperature is set.

2. HEATING PROCESS

Press **○** to start the heating cycle and stand at a safe distance.

There is a 5 second countdown before the cycle starts.

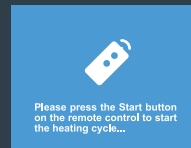
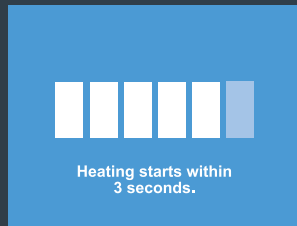

Alternatively, to start the heating process, press the start button on the remote.

When the preset temperature has been reached the heater will hold that temperature.

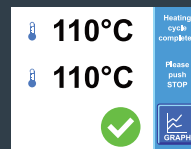
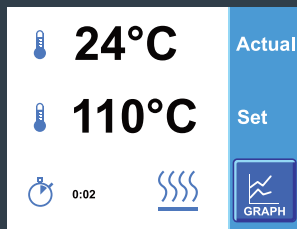

3. COMPLETION

Press **○** to stop the heating cycle.

The induction heater will now demagnetize.

Hereafter it will return to the first screen.

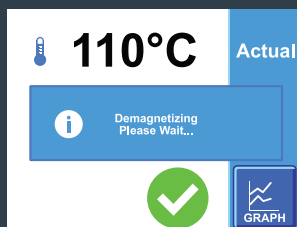



RAMP MODE

1. PREPARATION

To change the temperature press **110°C**, to change the heating time press **0:00**. Otherwise proceed to step 2.

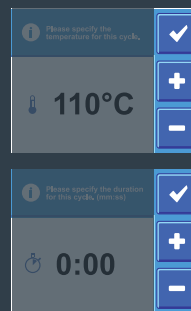
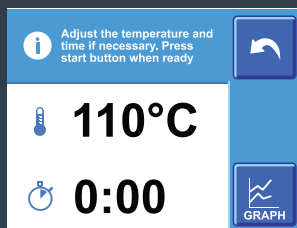

Press **+** or **-** to change the temperature (max. 240°C).

Press **✓** when the temperature is set.

Press **+** or **-** to change the time.

Press **✓** when the time is set.

2. HEATING PROCESS

Press **Start** to start the heating cycle and stand at a safe distance.

There is a 5 second countdown before the cycle starts.

When the preset temperature has been reached the heater will hold that temperature.

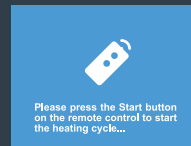
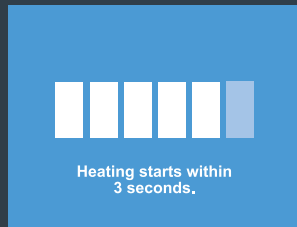

Alternatively, to start the heating process, press the start button on the remote.

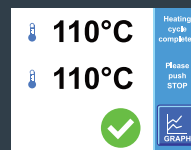
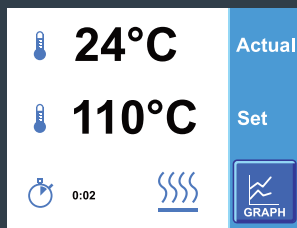

3. COMPLETION

Press **Stop** to stop the heating cycle.

The induction heater will now demagnetize.

Hereafter it will return to the first screen.

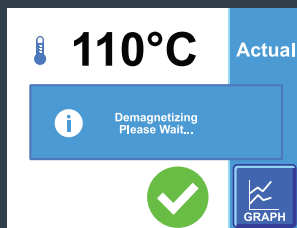



TEMPERATURE MODE, TWO SENSORS

1. PREPARATION

To change the temperature press **110°C**, to change the Δ temperature press **35°C**. Otherwise proceed to step 2.

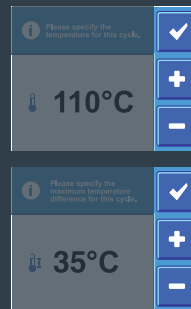
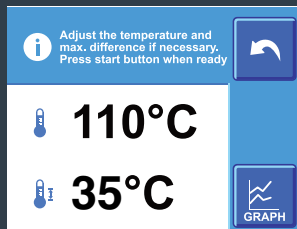

Press **+** or **-** to change the temperature (max. 240°C).

Press **✓** when the temperature is set.

Press **+** or **-** to change the Δ temperature.

Press **✓** when the temperature is set.

2. HEATING PROCESS

Press **○** to start the heating cycle and stand at a safe distance.

There is a 5 second countdown before the cycle starts.

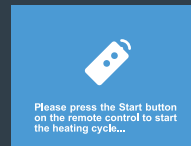
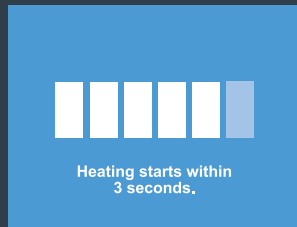

Alternatively, to start the heating process, press the start button on the remote.

When the preset temperature has been reached the heater will hold that temperature.

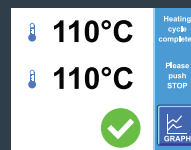
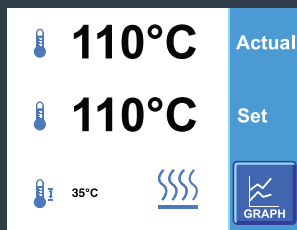

3. COMPLETION

Press **○** to stop the heating cycle.

The induction heater will now demagnetize.

Hereafter it will return to the first screen.

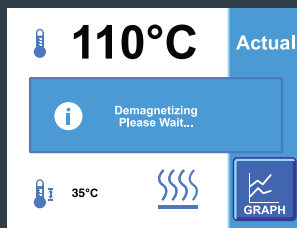



TIME MODE

1. PREPARATION

To change the heating time press **0:00**
Otherwise proceed to step 2.

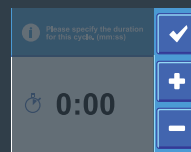
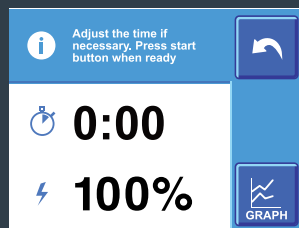

Press or to change the time (max. 99:59).

Press when the time is set.

2. HEATING PROCESS

Press to start the heating cycle and stand at a safe distance.

There is a 5 second countdown before the cycle starts.

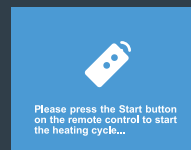
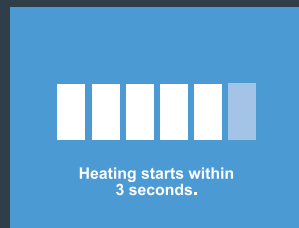

Alternatively, to start the heating process, press the start button on the remote.

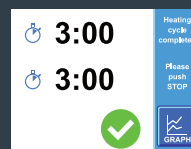
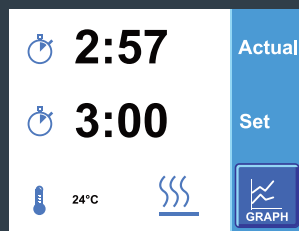

3. COMPLETION

Press to stop the heating cycle.

The induction heater will now demagnetize.

Hereafter it will return to the first screen.

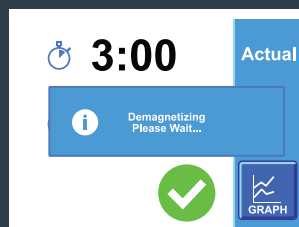

USER MENU

The user menu can be accessed by pressing the start/stop button for 8 seconds. Within this menu the user can view and/or change the following settings:

- U0 Reset to Factory Settings**
Each user setting will be reset to its original factory values.
- U1 Languages**
The languages of the heater can be changed to English, Spanish, German, and French. More languages can be added later.
- U2 Default Temperature (110°C)**
The default temperature can be set. The factory set temperature is 110°C (230°F).
- U3 Temp. Hold (On)**
Temperature hold can be turned on or off. During pendulation the heater will heat to the set temperature and cools down by 3°C, then heats again to the set temperature, etc.
- U4 Temp. Hold Duration (5:00)**
The duration of the temperature hold can be set. With the factory set duration of 5:00 min the heater pendulates indefinitely.
- U5 Completion Signal (On)**
The buzzer can be turned on or off. When on the heater will buzz when it reaches the set temperature. The factory set value is 'on'.
- U6 Temperature Unit (°C)**
The temperature unit can be changed to Celsius or Fahrenheit. The factory set temperature unit is Celsius, Fahrenheit in the USA.
- U7 Maximum Temp. Delta (35°C)**
The max. temperature difference between the two sensors can be set. The factory set temperature difference is 35°C (122°F).
- U8 Remote Control (On)**
The remote control function can be turned on or off. This setting is shown only when the remote has been included.
- U9 Calibration Sensor 1**
The temperature of sensor 1 can be set if it is calibrated incorrectly.
- U10 Calibration Sensor 2**
The temperature of sensor 2 can be set if it is calibrated incorrectly.
- U12 Start Delay (5)**
A delay can be set for the start of the heating process. When the user starts the heating process there will be a delay so to enable removal to a safe distance. The factory set delay is 5 seconds.
- U13 View Temp. Logging**
The temperature log from the previous heating cycle can be viewed here.
- U14 Screensaver (Off)**
The settings for the screen saver can be set here, ranging from off to a certain number of seconds.
- U15 Time (HH:MM)**
The current time can be set here. This information will be used when datalogging the heating cycle.
- U16 Date (DD/MM)**
The current date can be set here. This information will be used when datalogging the heating cycle.
- U17 Year (YYYY)**
The current year can be set here. This information will be used when datalogging the heating cycle.
- U19 Temp. Hold Hysteresis (3°C)**
The max. temperature difference before the heater starts heating again can be set here.
- U20 Auto Sensor Select (On)**
When this setting is turned on the heater can recognize the difference between Sensor 1 and Sensor 2 and assign the order automatically.
- U22 Time Range (MM:SS)**
The Time Range can be switched between MM:SS (minutes and seconds) and HH:MM (hours and minutes). This Time Range setting will be applied to the available range when using Time Mode.
- U24 Exit (Discard Changes)**
Any recent adjustments will be discarded and the user returns to the homescreen.
- U26 Update Firmware GUI**
When a USB drive (containing an update for the User Interface) is inserted this option will show. Press and follow the on-screen instructions to update the heater.
- U27 Update Firmware PWR**
When a USB drive (containing an update for the Powerboard) is inserted this option will show. Press and follow the on-screen instructions to update the heater.
- U28 Update Languages**
When a USB drive (containing an update for texts) is inserted this option will show. Press and follow the on-screen instructions to update the Fonts and Texts.
- U29 Cur. Version GUI**
The current version of the User Interface is shown here.
- U30 Cur. Version PWR**
The current version of the Powerboard is shown here.
- U31 Number of Cycles**
The Number of Cycles shows the amount of heating cycles for the induction heater.
- U32 Heating Timer**
The Service Counter shows the total time (all heating cycles added together) for the induction heater.

MAINTENANCE

6

- ▶ Store in a dry, frost-proof area, free from humidity.
- ▶ Keep clean with a soft, dry cloth.
- ▶ Keep the display clean for optimal responsiveness and to avoid any scratches.
- ▶ Keep the contact parts of the heater core poles greased. Grease regularly with an acid-free grease for optimal contact and to avoid corrosion (in the case of heaters with a pivoting yoke, also grease the vertical pin regularly).
- ▶ CRITICAL SPARE PART - Magnetic probe 0110010. Always use original spare parts, we can not guarantee a proper functioning using other parts.

Proper maintenance and handling practices are critical. Failure to follow installation and maintenance instructions can result in equipment failure, creating a risk of serious bodily harm.



WARNING

7

MALFUNCTION

If a loud vibrating noise is heard:

- ▶ Stop the heating cycle by pressing the start/stop button.
- ▶ Are the contact surfaces clean and greased sufficiently?
- ▶ Are the yokes 100% in contact with the surface? If this is not the case adjust the yoke with instructions below.

ADJUSTING THE YOKE

1. Check if the machine milled surface is smooth.
2. Place yoke or pivoting yoke on the heater.
3. Unscrew the screws in the yoke and pivoting point a quarter turn.
4. Turn on the heater and the yoke will set itself or use a nylon hammer.

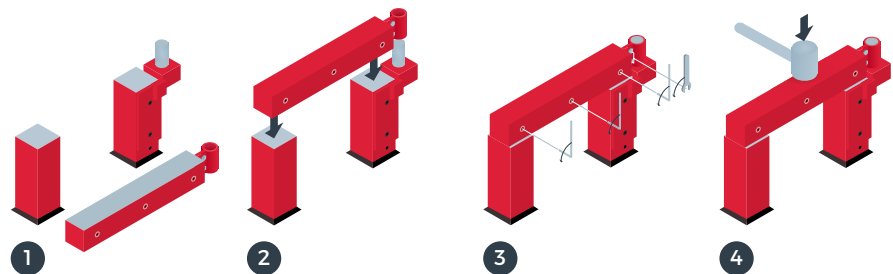

5. Fasten screws, turn off heater and the yokes are now adjusted.



WARNING

If in any doubt, isolate the induction heater and contact your local distributor. You can find the contact details for your nearest distributor on www.tminductionheating.com/distributors.



ERRORS

The induction heater can display two different kinds of errors: User errors (recognized by blue background) and Fatal errors (recognized by red background). The type of error message determines the difficulty of the action needed to make the induction heater function properly.

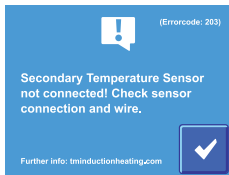

Most of the User errors are easy to solve, as the user interface will provide a suggestion for troubleshooting. The user should always end the troubleshooting by restarting the heater. If the error persists after troubleshooting the user can contact the local distributor. Contact details for the nearest distributor on www.tminductionheating.com/distributors.

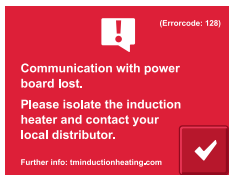

Fatal errors cannot be resolved without contacting the local distributor, as the problem is caused by an internal hardware or software error. When encountering a Fatal error the user must note the Error-code (found in the top righthand corner) and the operating conditions. Operating conditions may contain a description of the part that has been heated, the heating mode that has been used, and any other relevant information.

8 SPECIFICATIONS

SURETHERM 10X



Base dimensions: 450 x 210 x 275 mm

SURETHERM 20X

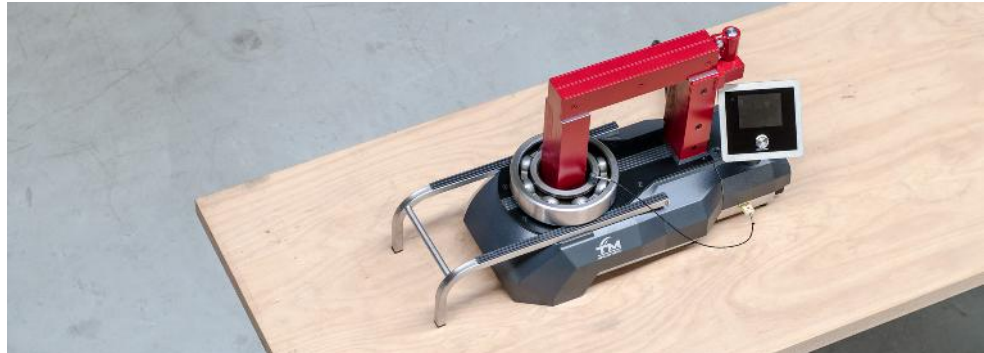

Base dimensions: 540 x 275 x 365 mm | Pivoting yoke

SURETHERM 30X

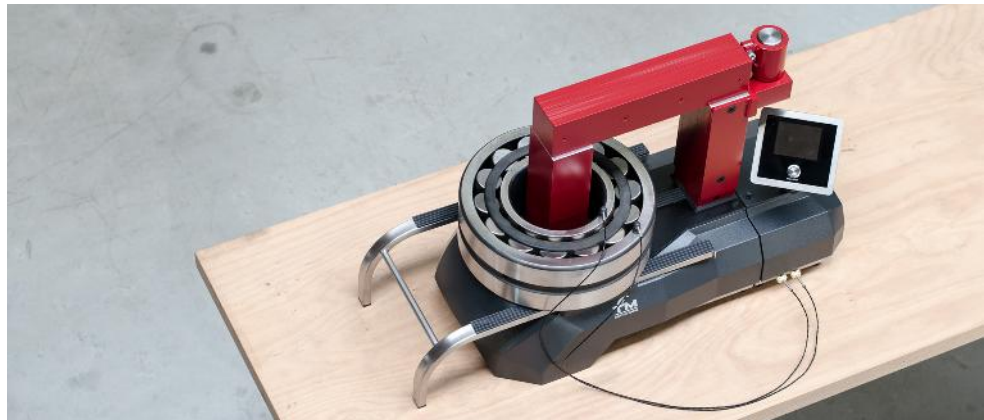

Base dimensions: 695 x 330 x 435 mm | Pivoting yoke



SURETHERM has an adjustable rack which gives it a larger surface area to hold larger workpieces. The heater core itself is non-adjustable. With a set of extension yokes the height can be extended.

DIMENSIONS

SURETHERM 10X

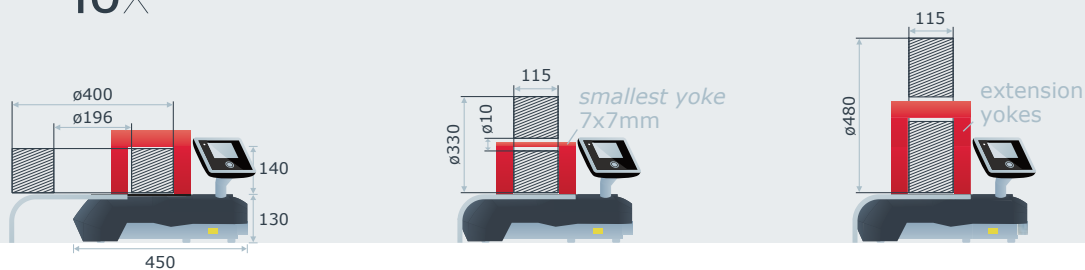

SURETHERM 20X

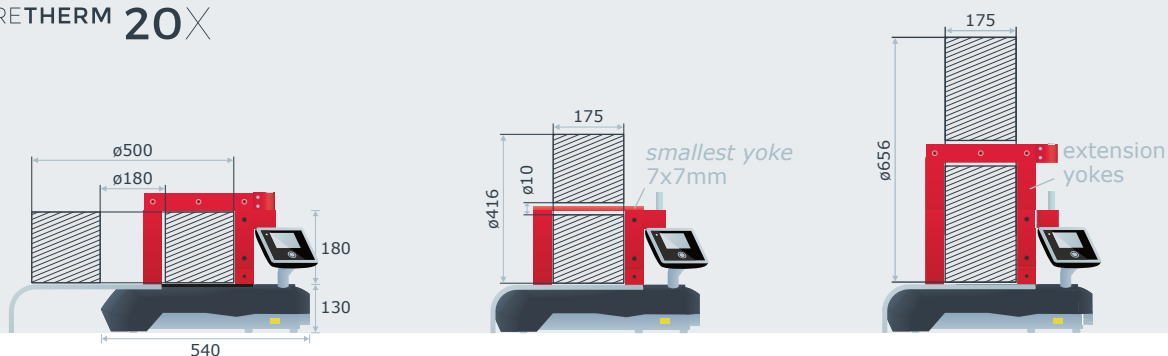

SURETHERM 30X

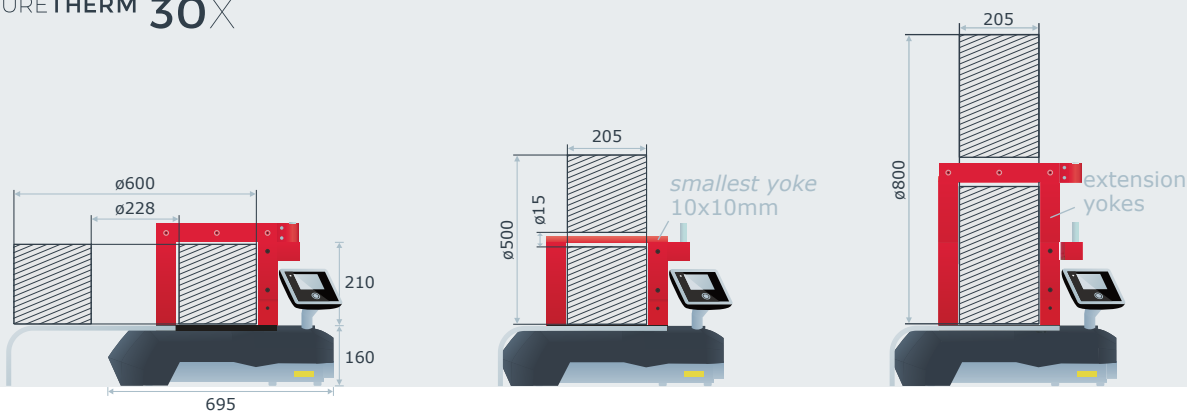

Workpiece dimensions shown here are extremes and depend on the yoke size used. See the table on the next page for an extensive overview.



HORIZONTAL WORKPIECE DIMENSIONS

(IN MILLIMETERS)

	SURETHERM 10X	20X	30X
Core dimensions	40 x 50	50 x 62	70 x 82
Min. bore	ø 66	ø 80	ø 108
Max. outer diameter	ø 400	ø 500	ø 600
Max. height	140	180	210
Max. height with extension yokes	215	300	360

VERTICAL WORKPIECE DIMENSIONS

(IN MILLIMETERS)

	Yoke	Min. bore	Max. outer diameter	Max. outer diameter with extension yoke	Max. width
SURETHERM 10X	7	ø10	ø297	ø372	115
	10	ø15	ø300	ø375	115
	14	ø20	ø304	ø379	115
	25	ø35	ø315	ø390	115
	30	ø40	ø320	ø395	115
	40	ø55	ø330	ø405	115
	25 + 40	ø78	ø355	ø430	115
	SURETHERM 20X	7	ø10	ø373	ø493
10		ø15	ø376	ø496	175
14		ø20	ø380	ø500	175
25		ø35	ø391	ø511	175
30		ø40	ø396	ø516	175
40		ø55	ø406	ø526	175
50		ø70	ø416	ø536	175
40 + 50		ø105	ø456	ø576	175
SURETHERM 30X	10	ø15	ø440	ø590	205
	14	ø20	ø444	ø594	205
	20	ø30	ø450	ø600	205
	30	ø40	ø460	ø610	205
	40	ø55	ø470	ø620	205
	50	ø70	ø480	ø630	205
	60	ø85	ø490	ø640	205
	70	ø100	ø500	ø650	205
	60 + 70	ø150	ø560	ø710	205



TECHNICAL DATA

		SURETHERM 10X	20X	30X
Electricity	Power rating	3 kVA	3.7 kVA	8 kVA
	Voltage	110 - 230 V	110 - 230 V	400 - 575 V
	Current max.	13 A	16 A	20 A
	Frequency	50 / 60 Hz	50 / 60 Hz	50 / 60 Hz
Controls for tension-free heating	Max. Temp. (1 sensor)	240°C	240°C	240°C
	Max. Temp. (2 sensor)	240°C ΔT 20 - 50°C	240°C ΔT 20 - 50°C	240°C ΔT 20 - 50°C
	Time	0 min - 99 hours	0 min - 99 hours	0 min - 99 hours
	Time / Temp. Ramp	5 min - 99 hours 5 - 240°C	5 min - 99 hours 5 - 240°C	5 min - 99 hours 5 - 240°C
Yokes (mm)	* = Standard P = Pivoting	7x7x200	7x7x280	10x10x350
		10x10x200	10x10x280	14x14x350
		14x14x200 *	14x14x280	20x20x350 P
		25x24x200 *	25x24x280 P	30x26x350 P
		30x26x200	30x26x280 P	40x38x350 P
		40x38x200 *	40x38x280 P	50x48x350 P
		n/a	50x48x280 P	60x60x350 P
		n/a	n/a	70x70x350 P
	Extension yokes (lxwxh)	40x50x75	50x62x120	70x82x150
Weight	21kg	40kg	85kg	
Max. weight workpiece	50kg	100kg	200kg	



EXTRA INFORMATION

Error report	Shown in display
Heating graph	Shown in display
Heating temperature (1 sensor)	Set and actual temperature, time, and power
Heating time	Set and actual time
Heating time / temp. ramp	Set and actual temperature, time, and power
External interface 1	USB 2.0 Port
External interface 2	Network Connection (optional)
Sound signal	Buzzer
Demagnetizing	<2A/cm
Magnetic probe	One piece
Temperature hold	Yes
Thermal safety guard coil	Yes

Languages	English, German, Spanish, French
Warranty	24 months
Extended Warranty	+ 12 months

Electrical drawing SURETHERM10X and SURETHERM20X

ELECTRICAL DRAWING

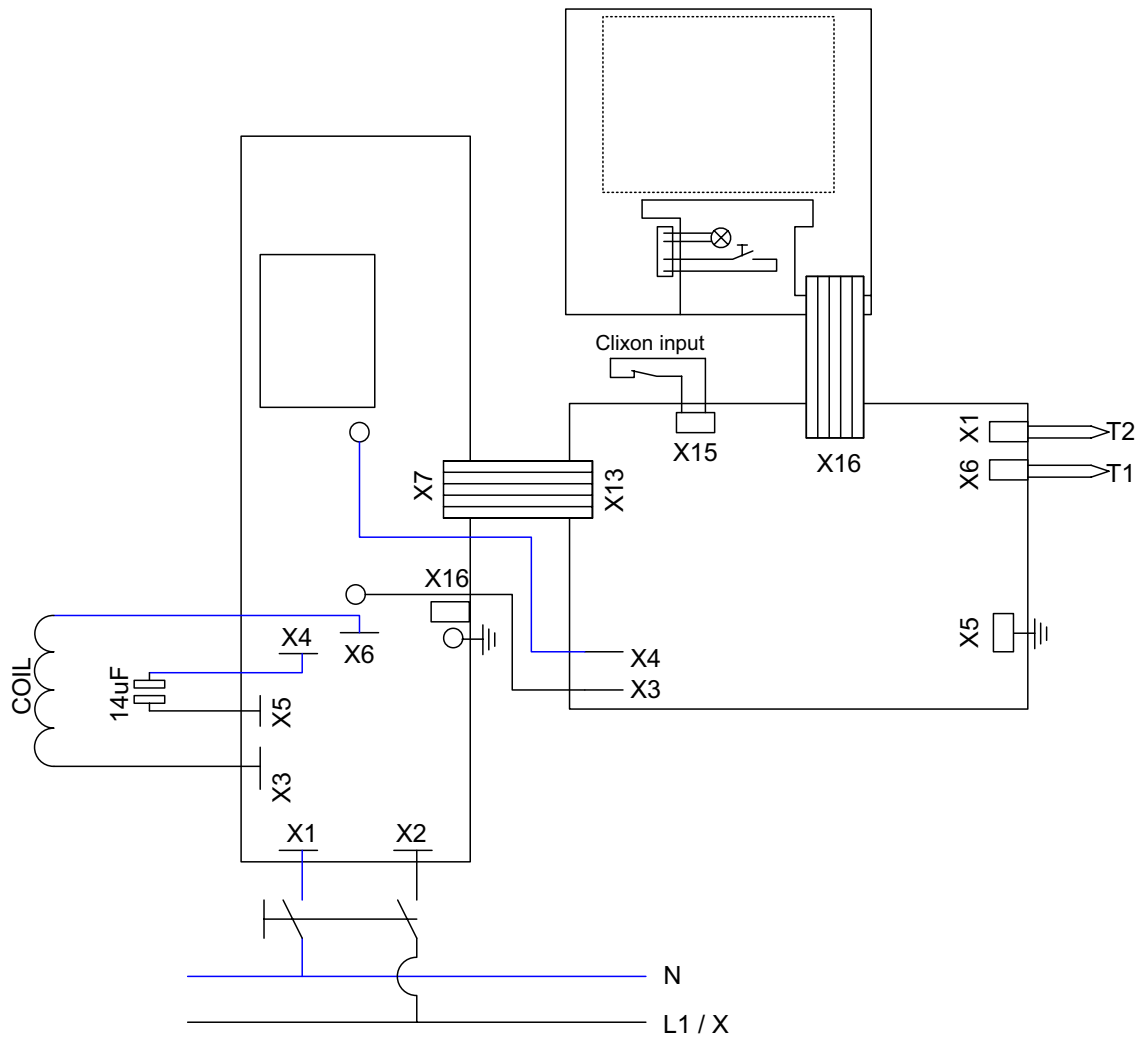

ELECTRICAL DRAWING

Electrical drawing SURETHERM30X

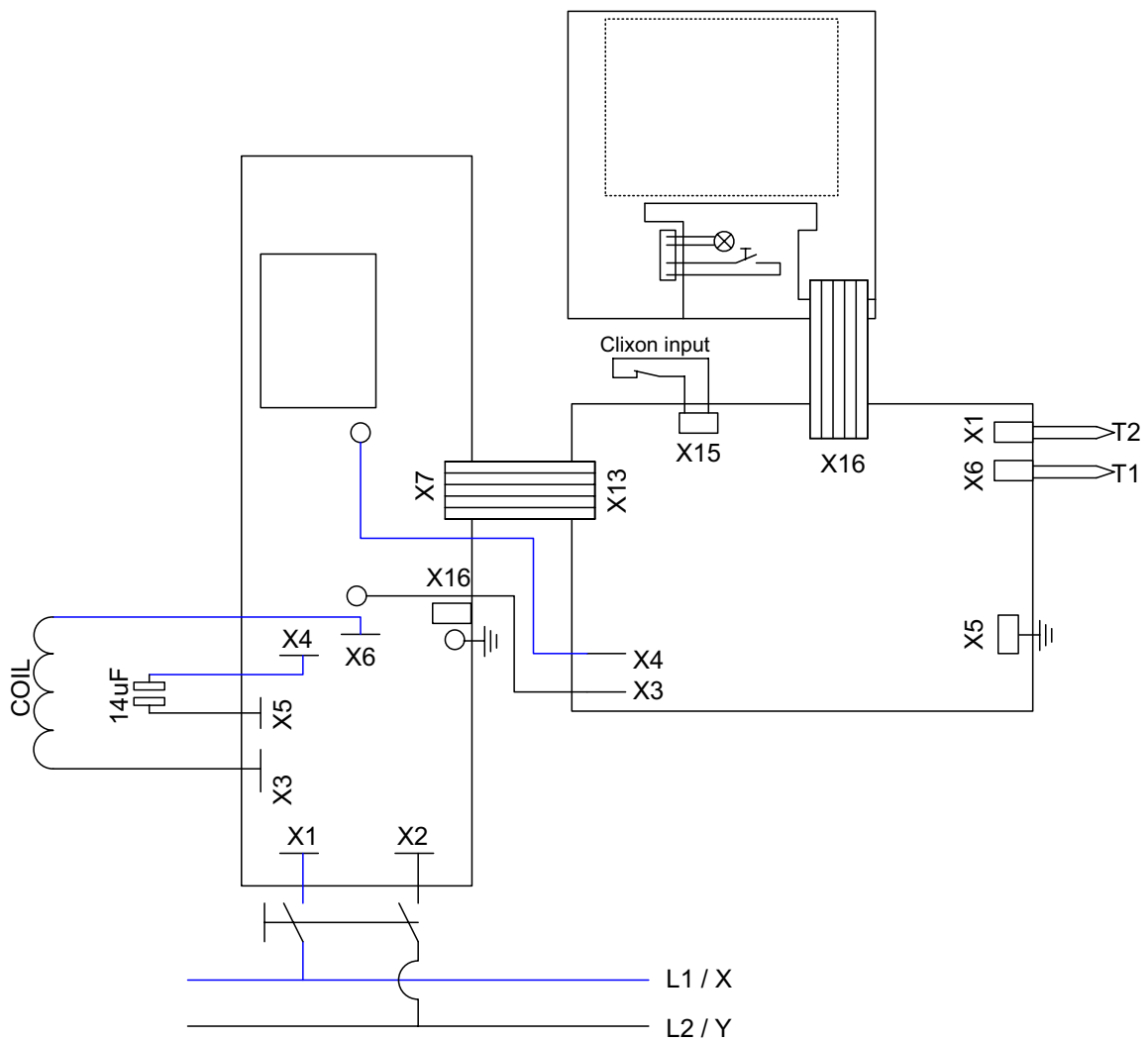

STATEMENT OF CONFORMITY

9

TM Induction Heating consistently provides products that meets customer and applicable statutory and regulatory requirements. ISO 9001:2008 specifies the requirements for a quality management system.



Management
System
ISO 9001:2008
www.tuv.com
ID 9108623968

A properly issued Declaration of Conformity has been established in order to ensure the quality of SURETHERM induction heaters. This declaration indicates that the product meets the requirements of the directives which are applicable. The SURETHERM induction heaters are manufactured in accordance with European regulations; CE compliant. As CE marking is a mandatory conformity marking for products sold within the European Economic Area these declarations do not cover any regions outside Europe. However, these declarations do ensure the quality of TM Induction Heating products.

SURETHERM

DECLARATION OF CONFORMITY

Manufacturer TM Induction Heating

Address Nobelstraat 14
3846 CG Harderwijk
The Netherlands

We hereby declare that the supplied version of

Name product Induction heater

Type product SURETHERM 10X

This product complies with technical standards specifications as defined by MACHINE DIRECTIVE 2006/42/EC, LOW VOLTAGE DIRECTIVE 2014/35/EU and EMC DIRECTIVE 2014/30/EU.

In conjunction with the following harmonized standards and where appropriate other technical standards and specifications:

Risk Assessment EN-ISO 12100:2010

Design & Manufacture EN-IEC 61000-4-6:2007/A1:2011
EN-IEC 60204-1:2006/C11:2010
NEN 3140/A1:2015

Name Mr. E. van Dijk

Function General Manager

Signature

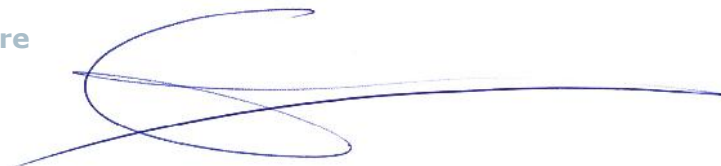

DECLARATION OF CONFORMITY

Manufacturer TM Induction Heating

Address Nobelstraat 14
3846 CG Harderwijk
The Netherlands

We hereby declare that the supplied version of

Name product Induction heater

Type product SURETHERM 20X

This product complies with technical standards specifications as defined by MACHINE DIRECTIVE 2006/42/EC, LOW VOLTAGE DIRECTIVE 2014/35/EU and EMC DIRECTIVE 2014/30/EU.

In conjunction with the following harmonized standards and where appropriate other technical standards and specifications:

Risk Assessment EN-ISO 12100:2010

Design & Manufacture EN-IEC 61000-4-6:2007/A1:2011
EN-IEC 60204-1:2006/C11:2010
NEN 3140/A1:2015

Name Mr. E. van Dijk

Function General Manager

Signature

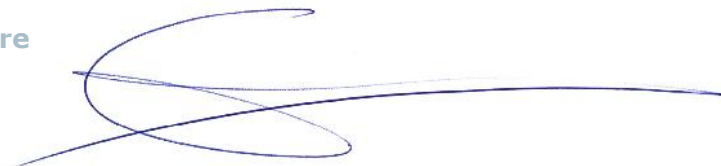

DECLARATION OF CONFORMITY

Manufacturer TM Induction Heating

Address Nobelstraat 14
3846 CG Harderwijk
The Netherlands

We hereby declare that the supplied version of

Name product Induction heater

Type product SURETHERM 30X

This product complies with technical standards specifications as defined by MACHINE DIRECTIVE 2006/42/EC, LOW VOLTAGE DIRECTIVE 2014/35/EU and EMC DIRECTIVE 2014/30/EU.

In conjunction with the following harmonized standards and where appropriate other technical standards and specifications:

Risk Assessment EN-ISO 12100:2010

Design & Manufacture EN-IEC 61000-4-6:2007/A1:2011
EN-IEC 60204-1:2006/C11:2010
NEN 3140/A1:2015

Name Mr. E. van Dijk

Function General Manager

Signature

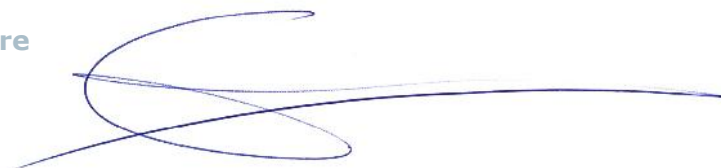



user manual
SURE**THERM**
version 2.0 - 2017

HEATING DONE RIGHT.

M&R
EQUIPMENT

TM
INDUCTION HEATING

Maintenance & Reliability Equipment

e: info@mrequip.com.au m: +61 417 954 430 w: mrequip.com.au